

The University of Louisville Foucault pendulum

Grawemeyer Hall
Belknap Campus

Edited by John Kielkopf, Professor
with contributions from
Roger Mills, Professor Emeritus
Charles Cowan, Electronics Technician, Retired
Pamela Graham, Research Assistant

Department of Physics and Astronomy
University of Louisville
Louisville, KY

November 29, 2005

1 Introduction

In 1978, a Foucault pendulum was installed in the Administration Building, now called Grawemeyer Hall, at the University of Louisville as a simple demonstration of the Earth's rotation.

The pendulum is supported from an iron structure spanning a skylight at the top of the dome of this Jeffersonian-style building. A large brass bob is suspended just above the lowest floor, approximately 80 feet below. The pendulum swings freely with a measured period of 9.4 ± 0.05 seconds, corresponding to a length of 22.0 meters (72 feet) for a ideal pendulum. The actual length is thought to be slightly greater (22.4 meters) but the radius of swing of this pendulum is not uniform as will be explained later. The plane of the swing slowly rotates, taking 38.7 hours to complete one turn. This motion is a consequence of the Earth's rotation, for indeed if we were at the Earth's North Pole looking down on the pendulum then it would appear to rotate clockwise once every sidereal day (23 hours 56 minutes), the time it take for the Earth to rotate once compared to distant stars. At the pole, the plane of swing would be fixed as the Earth rotated *counterclockwise* around it. At other latitudes the motion is more complex, and the pendulum's plane would not change if it were at the equator. One way to think about it is that the Earth's surface is moving under the pendulum, with points closer to the equator moving faster that points closer to the pole. In general the period is given by $24/\sin(\text{latitude})$. The same effect is responsible for the circulation that makes hurricanes or tornados.

This report was written to record the history of the pendulum, to document the details of its construction, and to provide instructions for its continued maintenance.

2 History of the Foucault pendulum project

The Administration Building was completely renovated in 1977. In the early days of the University of Louisville on Belknap campus, this building had been pressed into service beyond its planned functions and many interior changes had been made. As recently as the 1960's the ground floor remained partitioned into offices for the Bursar and Registrar, and the fact that the floor above had been open was long forgotten. During the presidency of Dr. James Grier Miller, the building was restored to its original appearance inside as well as outside. The first floor was reopened in the center so that one could look from the ground floor to the top of the dome in the rotunda. The original terrazzo floor that had been hidden under tile was revealed to show a stone compass rose replicating the iron work in the dome above.

In mid-1977, Mr. John M. Houchens, former Registrar, who had an interest in the Foucault pendulum, proposed to Dr. John A. Dillon, Jr., Vice President for Academic Affairs and a Professor of Physics, that it would be an interesting and educational feature



Figure 1: Grawemeyer Hall in 2005



Figure 2: Compass rose in the lower level floor of Grawemeyer Hall.



Figure 3: Grawemeyer Hall dome skylight. This composite image shows the skylight detail as well as the interior of the dome.

to add to the building, and that it fit naturally with the new open space and compass rose pattern. Dr. Dillon enthusiastically agreed, and he arranged for funding from a combination of private donations and restricted University funds. Some consideration was given initially to having the pendulum constructed by an outside firm, but it was realized that the expense would probably exceed the funds available. Dr. Dillon enlisted a group of persons from within the University whose knowledge and skills would enable them to make and install a Foucault pendulum, together with its drive and controls.

The design which was adopted is similar to one used by the California Academy of Sciences, but the details were developed independently here. A pendulum bob was designed and machined by Dr. Walter L. Moore, who had retired as a Professor of Mathematics a few years earlier and was then an Instrument Maker in the Physics Shop. Mr. Verne Baxter and Dr. Samuel Bell from the Department of Electrical Engineering developed the circuitry and sensing apparatus needed to maintain the steady swing of the pendulum by controlling a magnetic drive mechanism. Mr. John Takeuchi, Director of Facilities Management, designed for the portions which would be on public display. Dr. Roger Mills, a Professor of Physics also serving in the Office of Academic Affairs, coordinated the working group and designed the drive magnet and the pendulum support.

Plans for modification of the structural iron work supporting the dome to accommodate the pendulum mount were prepared by a licensed engineer in the firm of Senler-Campbell and Associates. The construction work was performed by a crew from Steel Fabricators,

Inc. (SFI), a Louisville firm. They performed the welding for the mount platform, and after additional machining by Dr. Moore, the platform was raised into position and installed some 72 feet above the ground floor level by their crew.

The pendulum bob and its fittings were machined by Dr. Moore from a single brass casting, made in a local foundry from a pattern designed and prepared by Dr. Moore. The weight of the casting was not accurately determined, but it was estimated to be between 170 and 180 lb. A small crane that had been built to install a telescope at the University's observatory (aptly now named in honor of Dr. Moore) enabled working with the casting in the lathe. He built a unique device to generate the spherical shape by pivoting the tool about a point under the center of the sphere as the brass turned in the lathe. After the last fine cuts were made with the tool, the bob was finished and polished by hand. The crane was used to move the finished bob into position in the Administration Building.

The pendulum was hung in the Spring of 1978 by Dr. Moore, Dr. Mills, and two students, Cyril Meyer and David Mattingly, from the Electrical Engineering Department. They were also involved in research projects for Master of Engineering theses relating to the sensing and drive electronics.

Since air resistance causes the swinging pendulum to lose energy, it comes to a stop in about two hours after it is started at full amplitude. To overcome this tendency, at each swing, a drive magnet imparts a small impulse to make up for the energy lost. The magnet is activated by a pulse of electrical current controlled by electronic circuits connected to sensors to determine the moment when the pendulum bob has reached the center of its swing. In the first years in which the pendulum was installed, the sensing device was located at floor level in the light ring. This feature also has 360 red light emitting diodes in its top surface which were used as indicators of the apparent precession of the plane of oscillation of the pendulum. The sensing itself was done using one of two light beams near the floor which were interrupted as the tip of the pendulum passed through them. The design, installation, and maintenance of the electronic components which sensed the interruption of the light beam and initiated the current pulse to the magnet was done under the supervision of Mr. Baxter and Dr. Bell. They worked first with Electrical Engineering students Mr. Mattingly and Mr. Meyer, and later with Ms. Shayesteh Khosravi-Kamrani. The final "first generation" design was based on counting the interruptions of the light beam to regulate the position of the activated red light and of the active sensing light beam. Experience showed that the events became unsynchronized after several days had passed, and it was necessary to reset the system manually every few days of operation.

The original concept was to mark the progression of the pendulum with an LED, and the design of an attractive light ring to hold them was the work of Mr. Takeuchi. The metal parts for the ring were made by Dr. Moore, and finish work with its wooden trim was done by Mr. Lee Tucker, a master carpenter in the Physical Plant Department. A bridge at the northward side of the ring was included so that the flourish in the design of the compass rose would not be obscured. In use, unfortunately, the electronics could not trigger each red LED

accurately, and the ring display only approximated the position of the pendulum. precision that would be needed to switch each of the 360 lights.

In late 1988 and early 1989, a group from the Physics Department, Mr. Charles Cowan, Electronics Technician, Mr. Ron Smith, Instrument Maker, and Dr. Mills, redesigned the sensing device. The original LED display was abandoned in favor of a simpler set of mechanical pins that visitors could reset, and the new electronics and sensors were located with the pendulum mount at the top of the dome. Since it remains in operation now, 17 years later, it is described more fully below. With this system the pendulum will run for months with no need for maintenance. Casual observers easily see the motion of the plane of oscillation when plastic pins, set upright every ten degrees, are knocked over as the pendulum moves past them. Visitors often reset the pins themselves, or someone working in the building takes the responsibility of “keeping the Earth rotating.”

3 Description of the Pendulum

The pendulum bob is composed of several brass pieces, all made from the original casting. These can be disassembled to access the fittings which capture the aircraft control cable used to support the bob in its swing. The radius of the central portion of the bob is 11.5 cm (4.5 in), and the two caps are approximately frustrums of cones 12 cm (4.7 in) high, and with greater and lesser radii of 3.0 cm (1.2 in) and 2.5 cm (1.0 in), respectively. The spindle is cylindrical, with height 7 cm (2.7 in) and radius 1 cm (0.4 in). The mass of the assembled bob is not precisely known, but we estimate it based on its density and dimensions to be 59 kg (a weight of 130 lb). The statement made in the leaflet available in March 1990 at the pendulum site lists the weight of the bob as 178 lb. This is comparable to the weight of the original casting before machining. The suspension cable, standard 1/8-inch diameter aircraft control cable, was tested for load capacity in the Civil Engineering Department and found to be capable of sustaining a weight of over 1200!lb, thus guaranteeing an ample safety margin. Over the 27 year life of the pendulum at this time, there has been no observable sign of cable wear.

The components of the mount are inaccessible to the public, and with present OSHA regulations can be accessed only by personal with appropriate precautions for working above the dome framework. The photographs shown here date from the installation.

The structural members painted red are portions of the main framework supporting the dome. The white panels at the bottom are translucent panels of frosted glass or of plastic which are set into the iron straps which are bolted to the support members to form the framework seen from below as the compass rose. The pendulum platform itself rests on supports attached to the structural members. The platform is held in place by its weight, and is not rigidly attached to the structural members. The platform in fact rests on Teflon discs on brackets, and the position of the platform can be adjusted along two mutually



Figure 4: The Foucault pendulum bob.

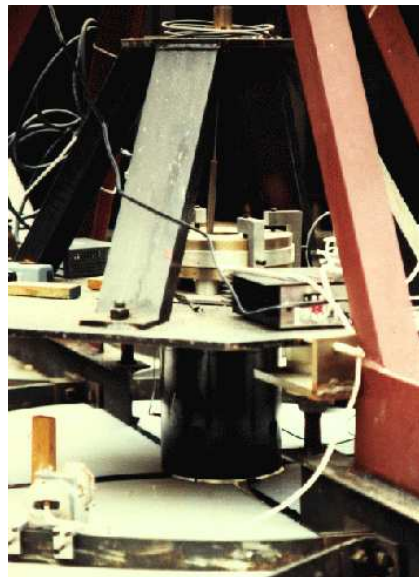

Figure 5: The support framework showing the drive magnet.

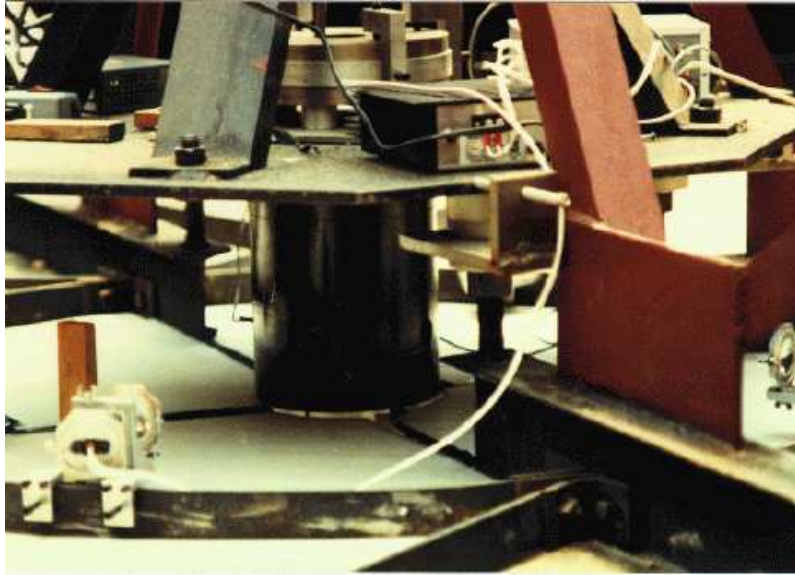

Figure 6: The support showing the lenses and lamps used to trigger the magnet.

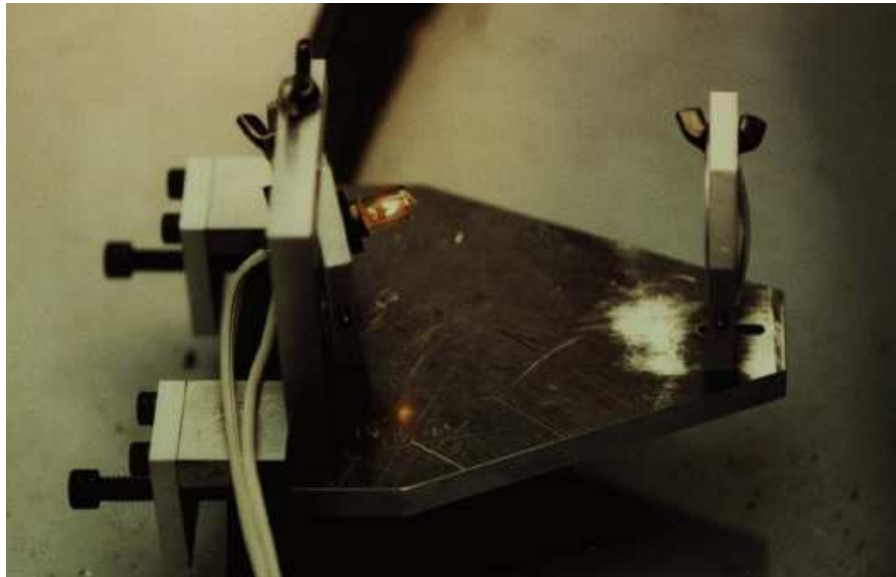

Figure 7: Detail of the illuminator.

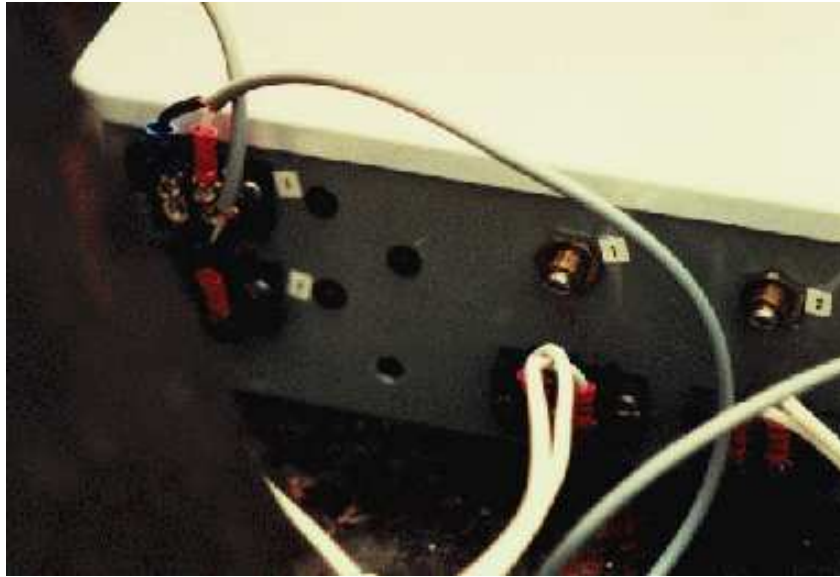

Figure 8: Coincidence detection circuit box.

perpendicular directions so that the assembly can be centered relative to the compass rose in the terrazzo below. Movement of the platform is accomplished by turning bolts mounted in the brackets, and which bear on the platform edge. One of these bolts is visible, somewhat out of focus, as the white object near the middle right-hand edge of the figure.

A blackened cylinder appears below the platform and serves both to obscure overhead light from the hole within which the pendulum cable moves, and to locate the sensors for the light beam used to determine the moments at which the cable passes through the center of the swing. Two such beams pass through holes in the cylinder to photodetectors in the far side of the cylinder. A wire leading from one of these detectors can be seen next to the left side of the cylinder. The light sources are mounted so that they project beams at right angles. One of the mounts for the sources is seen next to the wooden block at the lower left of the picture. The cylindrical object at the center of the figure is the drive magnet. It is held against the platform by Z-shaped braces, and it can be centered independently of the platform by the adjustment of the setscrews in the Z-braces. A hollow rod to which is attached an iron disc surrounds the cable. It swings within the magnet and couples the support cable to the magnetic pulses of the drive.

The cable itself passes through a brass bushing (cut from the original casting) and then through a second brass fitting (also from the casting) where it passes through an shaped hole and is seized by set screws. The hole in the bushing is where the bending of the cable occurs. In order to avoid stressing the cable at a particular point which could result in fatigue or

breaking of the cable, the inside of the bushing is flared toward the bottom, approximating an evolute to the surface traced out by the pendulum bob. The bending of the wire as the pendulum swings then is distributed over approximately one inch of the cable, resulting, as noted earlier, in a shortening of the radius of the swing by about an inch from the center to the maximum of the swing. (The action of the magnet also causes a momentary displacement of the center of the swing, also a slight divergence from the description of an ideal simple pendulum.) The final fitting is held firmly in place by the weight of the pendulum bob. It does not move at all relative to the platform (or to the building itself). The only moving part in the whole assembly is the pendulum itself. The magnet power supply rests on the platform near the magnet, to the left. At the right, one can see the power supply for the electronics which respond to the light sensors controlling the actuation of the magnet. A third component box, not visible in this photograph, contains the coincidence circuits and the adjustment controls.

The magnet is cylindrical in configuration so that the swing is not biased in any particular direction. It was carefully machined and wound by Dr. Moore to achieve this configuration. The circuitry triggers at the center of a swing and then actuates the magnet near the end of its swing so that it attracts the disc near the top of the cable. The timing of the electrical current pulse which actuates the magnet is controlled by the optical sensors.

The second-generation sensing assembly consists of two beams of light oriented to cross at the center of the swing of the pendulum. In contrast to the old design in which only one beam was active at a time, both of the beams are always on. This eliminates the need to switch from one to the other. The event which initiates the current pulse occurs when both beams are *simultaneously* interrupted. Even when the plane of oscillation happens to be parallel to one of the beams, this simultaneous event can occur only where the beams cross. The fact of the simultaneous event is detected when signals from light sensitive components combine in a coincidence circuit. The successful detection activates a timing circuit which then pulses the magnet. In essence, the timing is reset at the middle of each swing, and there is no accumulated error. The circuits are normally powered for twenty-four hours each day. If the pendulum is interrupted in its swing by a viewer, or if there is a power failure, there may be a need to restart the pendulum swing, for the pendulum's drive magnet is effective only if the pendulum is swinging at or near full amplitude. On any of the lower floors, a light click should be heard near the end of each swing. This is due to the iron disc being drawn up into the slotted magnet, and it is a sure indicator that the magnet is functioning correctly. If the clicks are not heard, or if they are heard only when the pendulum is swinging to one side, the pendulum will need attention. A full swing is easily noticed, for it will carry the bob over the light ring on the ground floor by about six inches. As stated, if the swing is reduced in some manner so that the bob does not reach the light ring, it will probably need to be boosted for the magnet to again become effective.



Figure 9: The pendulum in motion.

4 Maintenance of the Pendulum

Mechanical maintenance of the parts of the pendulum will ordinarily be minimal. These consist of two types of problems: starting the pendulum, and alignment. There will, of course be a need to reset the plastic pins on a daily basis, but that task requires no instructions.

It may become necessary to restart the pendulum if it should be disturbed by touching, or if the power to the magnet is turned off long enough for the pendulum's amplitude to be damped to the point where the magnet can no longer be effective. Boosting the pendulum swing is easily done by a short gentle push against the control cable toward the center of the compass rose. Once full amplitude (enough to swing the bob four to six inches over the light ring) is reached, the position of the bob at the bottom of each swing, back and forth, should be observed. If the position relative to a point at the center of the compass rose is the same, the motion is planar, and no further correction is needed. If the position shifts from the swing away from the observer to the swing towards the obser, the bob is ellipsing, and the sidewise component should be damped out. This is also easily done. Observe whether the lowest position of the bob shifts on the swing away to the right or to the left. Lightly the left or right side of the cable until the shift no longer appears, or at least is reduced to a small fraction of an inch. Some ellipsing may recur naturally as the pendulum bob swings, but this will be small and is not of importance. Any sidewise motion of the cable at the bushing in the mount also tends to reduce ellipsing, so the natural tendency is for the swing to be nearly planar.

4.1 Alignment of the Pendulum Assembly

Once aligned, the major assembly itself should be secure (barring a deliberate attempt to dislodge the platform) against almost anything short of an earthquake. If there should be some concern about the fact that the platform is held in place only by its own weight, the addition of clamps to secure it could be easily done. However, should the improbable occur, the following instructions for realignment should be adequate.

There are two mechanical adjustments which must be made. The first is aesthetic, centering the swing over the lower compass rose. With the pendulum bob hanging at rest, the bolts contacting the edge of the platform should be adjusted so that the bob is centered over the pattern once again. Note that this adjustment has not needed correction during the first dozen years of operation of the pendulum. The second mechanical adjustment is more important. In order that the magnet can best serve its purpose, it is necessary to adjust its position so that it will give maximum boost on each end of the swing. Thus the magnet should be aligned so that its center coincides with the center of the swing. In order to do this the pendulum should be started so that its amplitude is just enough to cause the magnet to catch the iron disc on either side of the swing. This can be done at the floor level or at the platform level. The side of the magnet where the magnet does not catch the disc is then

too far from the center, and it should be moved toward the center by loosening the upper setscrews in the Z-pieces and adjusting the setscrews in the legs. The procedure should be repeated until the disc is caught by the magnet equally well on either end of the swing. The same procedure should then be applied after the plane of swing has been changed to one which is perpendicular to the first plane. Once done, the setting in the original plane should be checked once more to assure that the second adjustment (if any) did not disturb the first one. Securing the magnet in position with the upper setscrews should guard the magnet's position against any further shifts.

4.2 Alignment of the Sensing System

Since the sensing system is mounted at the platform level, the alignment must be done at that position. Pieces of plywood which will fit over the iron work are stored in the upper part of the dome near the platform, and should be placed in position to assure safe footing when doing any work at this level. Care should be taken in handling the plywood pieces. The inner dome itself consists of a thin shell of plaster, and can be easily penetrated. Further, the plates of glass in the compass rose frame are not tempered, and break easily.

The sensing system is composed of two light sources, two detectors, and an electronic circuit which triggers a pulse when both light detectors simultaneously receive no light. Two dummy sources are also present only to preserve the symmetry of the pattern when seen from the floor below. The light sources include a high intensity light bulb mounted in a holder placed before a focusing lens. The resulting beam is oriented so that it enters the blackened cylinder below the platform through a one inch hole and proceeds through, unless obstructed, to a photodetector mounted on the opposite side of the cylinder. Since the bulbs are not built to strict uniform specifications, the variance of the position of the filament is accommodated by mounting the bulb holder on gimbals. The light source itself is clamped to one of the curved pieces of iron forming the upper compass rose, and can be shifted from side to side if need be. The focusing lens can be adjusted back and forth before the bulb so that the beam is focused on the cable when it is in the center of its swing. Working sketches of the mount details were prepared by Mr. Ron Smith and are included in the Appendix.

There is a triangular configuration of LED's on the coincidence electronics box. When the beams are unobstructed, the LEDs are off. When the left hand beam, the one from the source shown in figure above is obstructed, the LED labeled "1" lights. When the right hand beam is obstructed, the LED labeled "2" lights. When both beams are simultaneously obstructed, all three LEDs will light. The light bulbs have an average rated life of 3000 hours when operated with 0.20 A at 14 V. In these light sources, the bulbs are operated at 11 V to extend the lifetime of the bulbs. It is estimated that at this level of use, the lifetime will be about 10,000 hours. When first installed, the bulbs operated for about 400 days (9600 hours) before an interruption in service occurred which made it necessary to change them.

Alignment of the light sources consists of placing the light bulb in the holder, and focusing

the beam on the cable. A piece of rubber tubing has been attached to the cable at the level of the beam to make the focusing less critical, but this should still be done with some care so that there will be maximum occlusion of the beam when the cable swings through it. The bulb should be maneuvered in the mounting so that the trigger LED which is associated with it is extinguished when the pendulum's cable is away from the center position. Except for assuring that the beams are as nearly perpendicular as possible, the two beams can be focused and aligned independently of each other. The coincidence event which initiates the timing of the pulse of current to actuate the magnet occurs when the cable obstructs both beams at the center of the swing, regardless of the orientation of the plane of oscillation.

5 Afterthoughts

Aside from resetting the pins daily, the University of Louisville Foucault pendulum requires little maintenance. If the swing should be disturbed, the pendulum is easily restarted. If upon restarting, it is not possible to hear the distinctive click near the end of each swing caused when the magnet seizes the disc, one should first check to see that the power to the magnet is on. If the power is on, and the clicks are still not audible, it is necessary to check the functioning of the light bulbs which provide the sensing beams. If one of these is burned out, it can be replaced following the procedure stated above. Since the cost of the bulbs is nominal, it would be sensible to replace both when either burns out since the remaining one will probably go before much more time has passed. It might be just as well to replace the bulbs on a regular schedule, perhaps yearly. It may be desirable to polish the pendulum bob when there are occasions of ceremony in the building.

6 Appendix: Electronics

The accompanying hand-drawn schematics show the second-generation circuitry for driving the pendulum.

There are two light beams which cross at 90° at the center of the pendulum's swing. For each beam there is an incandescent lamp and a matching phototransistor sensor. The light beams are established by two lenses. The mounts for the lenses and lamps provide enough adjustment that the lamps are focused to intersect on the cable at the center of its swing. Drawings for the lens mounts are shown in the next section. A lamp and lens mount is visible in the photographs above.

The circuits for each lamp-diode pair are identical, and labeled on the schematic as BEAM1 and BEAM2. The GE 1487 lamps are 13 V rated but operated at 11 V for a longer lifetime. The phototransistors are TIL414 which control the input of an LM339 quad operational amplifier. The voltage at the outputs of the op-amps is either 0 or $+V$ depending on the illumination of the phototransistor. These outputs are labeled as "1" and "2" on the coincidence board schematic. Diagnostic LED's turn on when either beam is blocked by the pendulum cable.

A CD4011 quad nand gate provides coincidence detection for the state when both beams are blocked. The outputs "1" and "2" of the op-amps are input to the first nand gate and the second nand is used simply to invert that state. Another diagnostic LED turns on when both beams are broken in coincidence. The coincidence detection pulse at "3" triggers a delay circuit.

The delay circuit board uses 3 sections of a CD4050 hex non-inverting buffer to shape the coincidence pulse. The output of this buffer is a 0 to $+5$ volt pulse at 4 on the delay circuit board schematic. The buffered coincidence pulse triggers a delay timer based on a 74121 monostable multivibrator. Following this delay, another 74121 determines the duration of the magnet power pulse. The combination of the two timers creates an off-on-off $+5$ V TTL pulse that controls the magnet power supply. A diagnostic LED turns on whenever the remote magnet power supply is turned on.

Current for the magnet is derived from a Lambda LRS-52-12 power supply. The current is controlled by a TTL remote on/off feature of this supply. SK9097 diodes in the output of the supply are used to control ringing. The 33 mH, 1.6Ω , magnet coil is connected directly to the supply as shown on the schematic.

The coincidence and delay boards are mounted in a box with the LED's on the front panel.

The magnet is a stationary coil wound inside a split cylindrical soft iron case shown in Section AA on the sketch in the appended mechanical drawings. The bore of the magnet is a cone through which the pendulum support wire hangs. There is an iron disk attached to this wire. The disk is pulled into the iron magnet whenever the coil is actuated. Details of the coil are not available, but its resistance and inductance are noted on the schematic.

FRONT PANEL

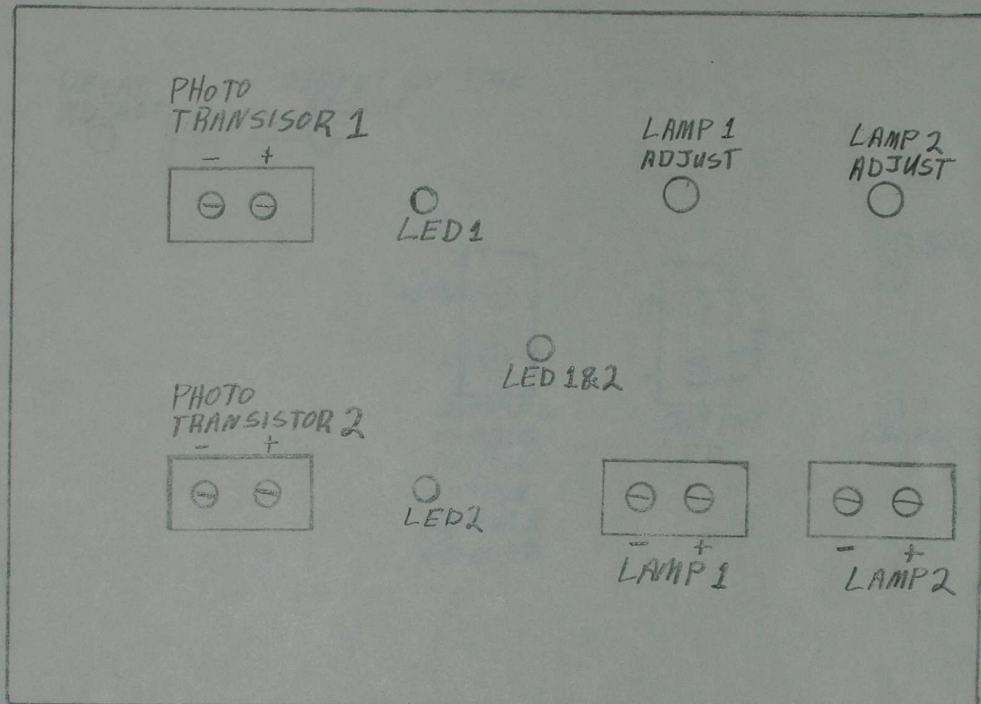

NOTE: LAMP VOLTAGE ADJUSTED TO 11 VOLTS.

BACK PANEL

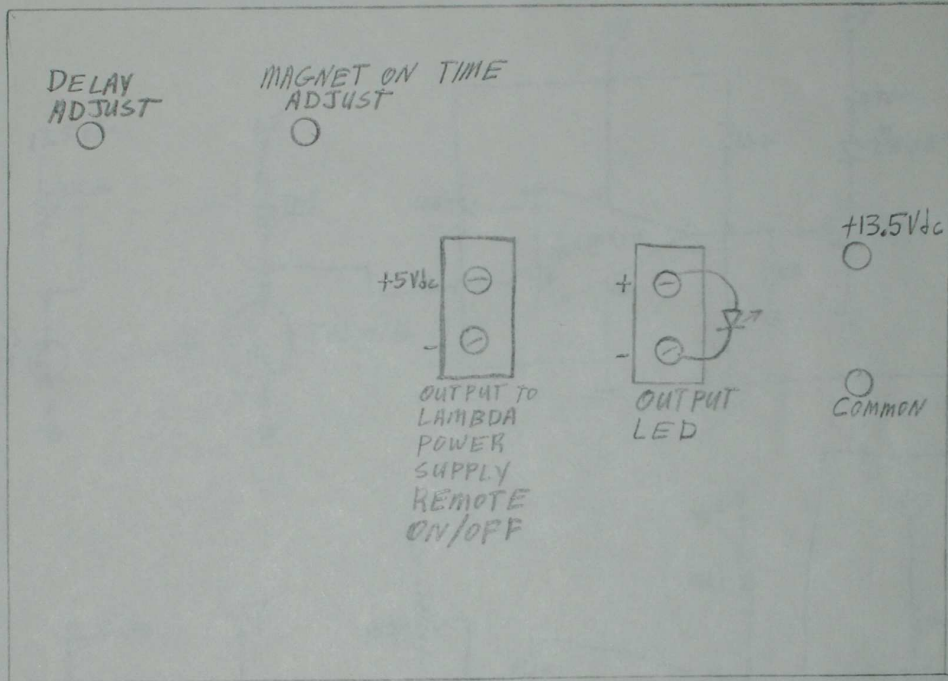

THE RIBBED CONDUCTORS ON THE LAMP CORDS
ARE CONNECTED TO COMMON OR THE LOWER VOLTAGE.

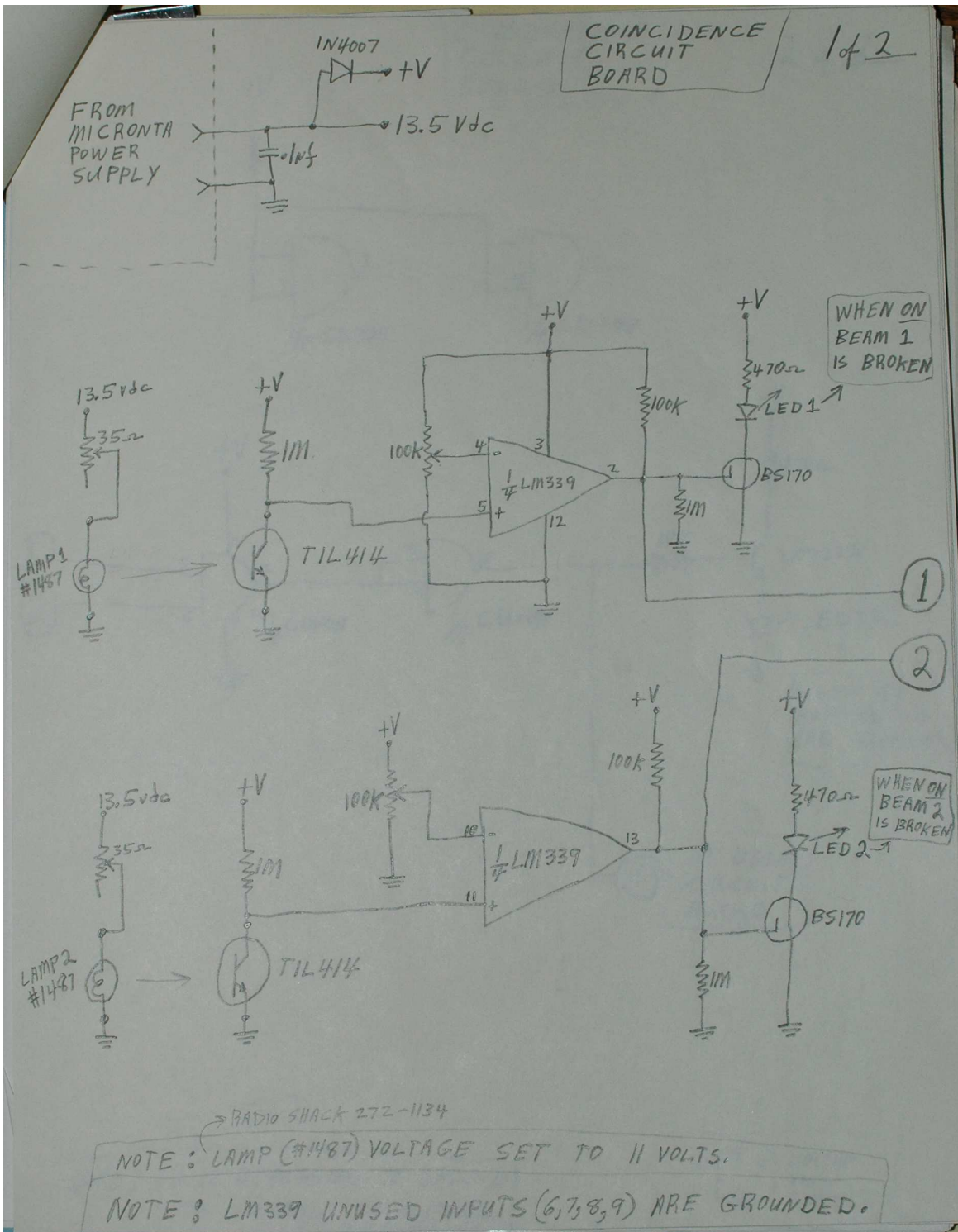

COINCIDENCE
CIRCUIT
BOARD

2 of 2

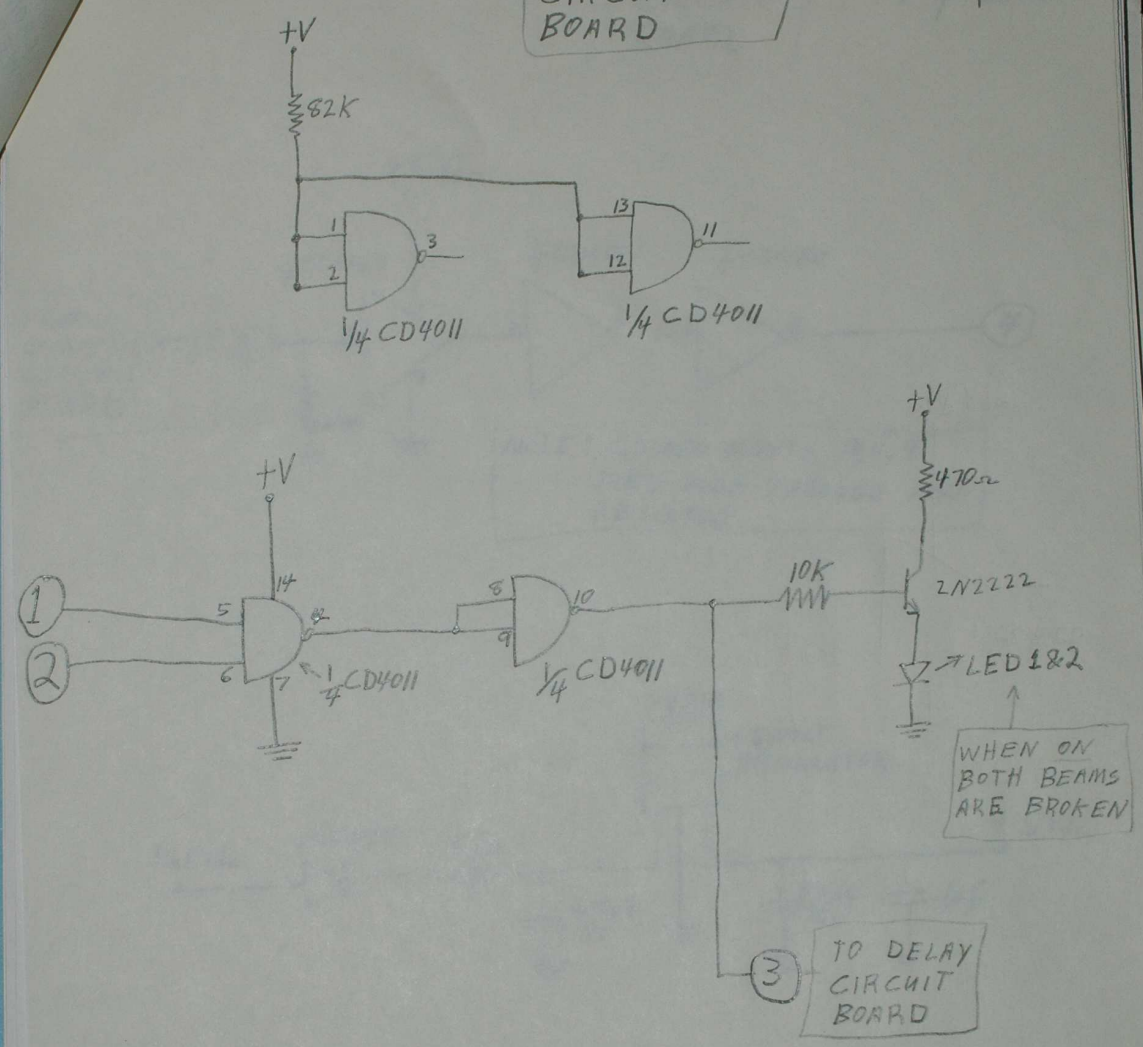

+V ~ +13.0V
NOTE: +V IS BYPASSED TO GROUND
WITH CERAMIC CAPACITORS.

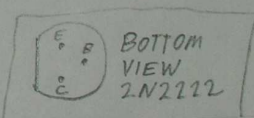

DELAY CIRCUIT BOARD

1 of 2

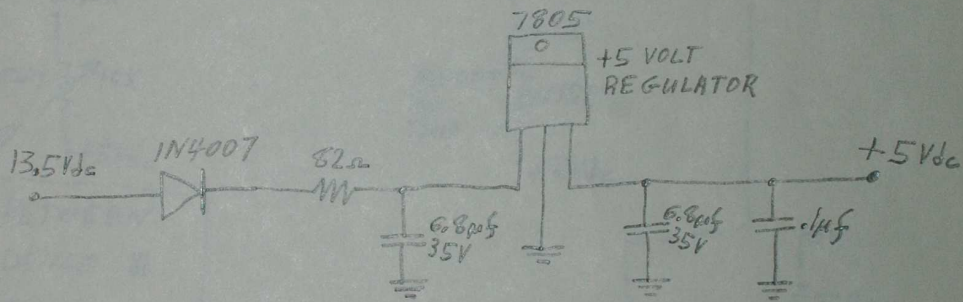
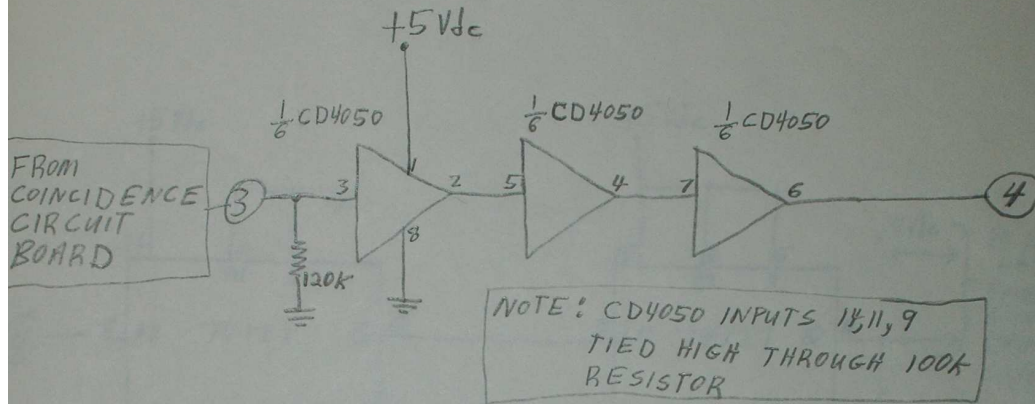

DELAY CIRCUIT BOARD

2 of 2

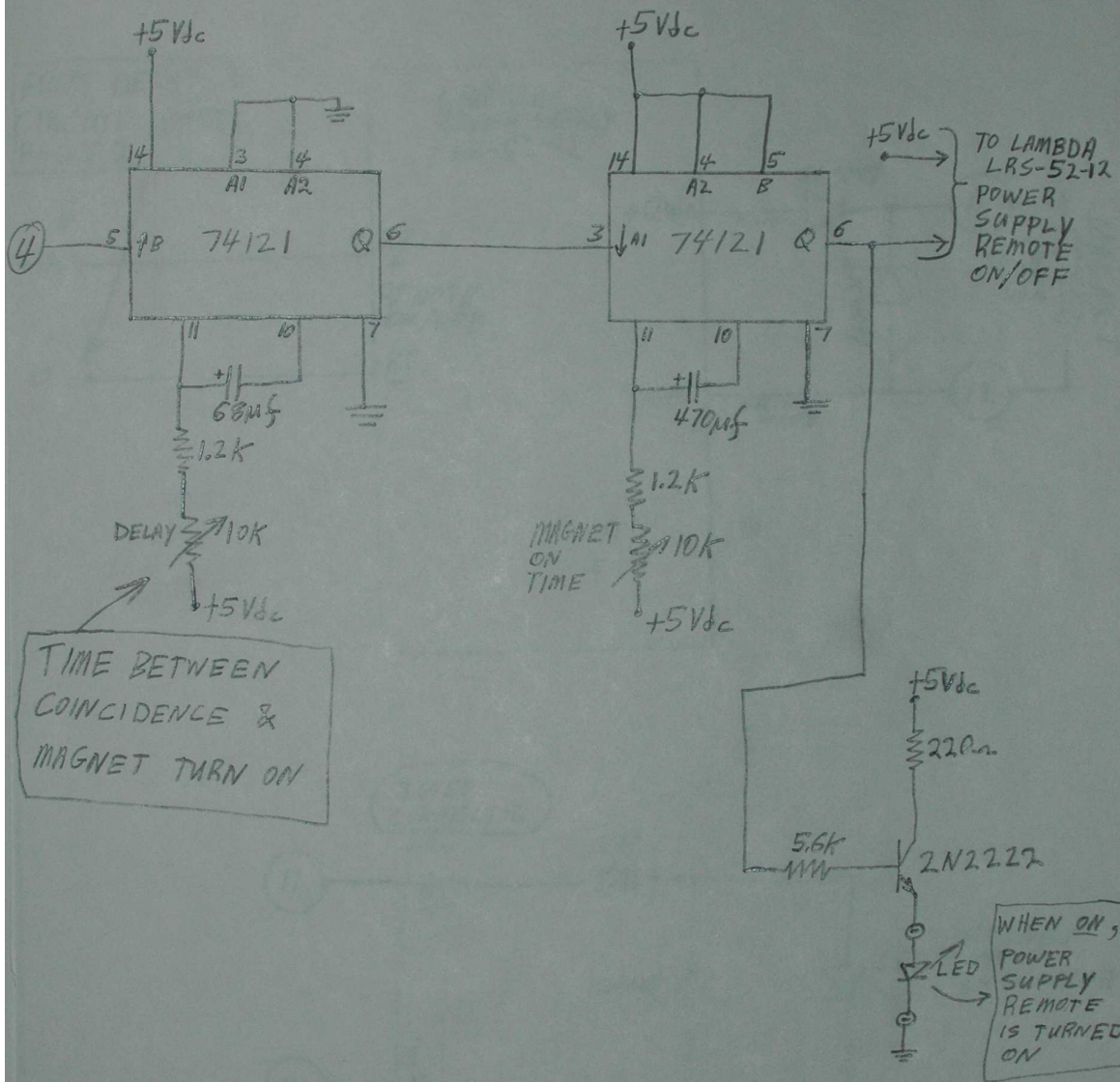

LAMBDA POWER SUPPLY AND MAGNET

FROM DELAY CIRCUIT BOARD PAGE 2

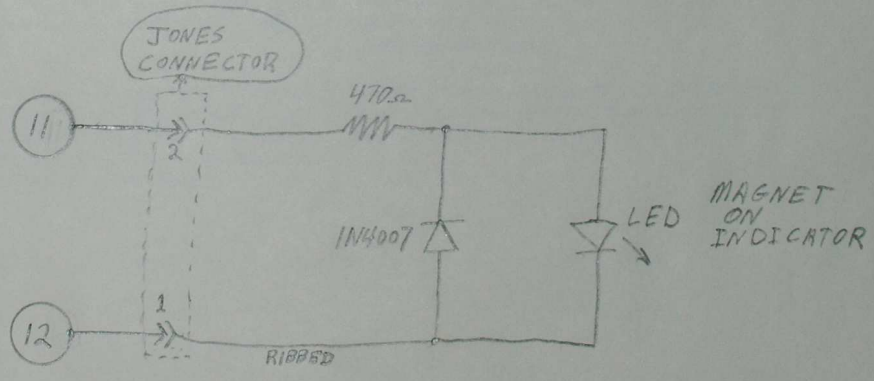
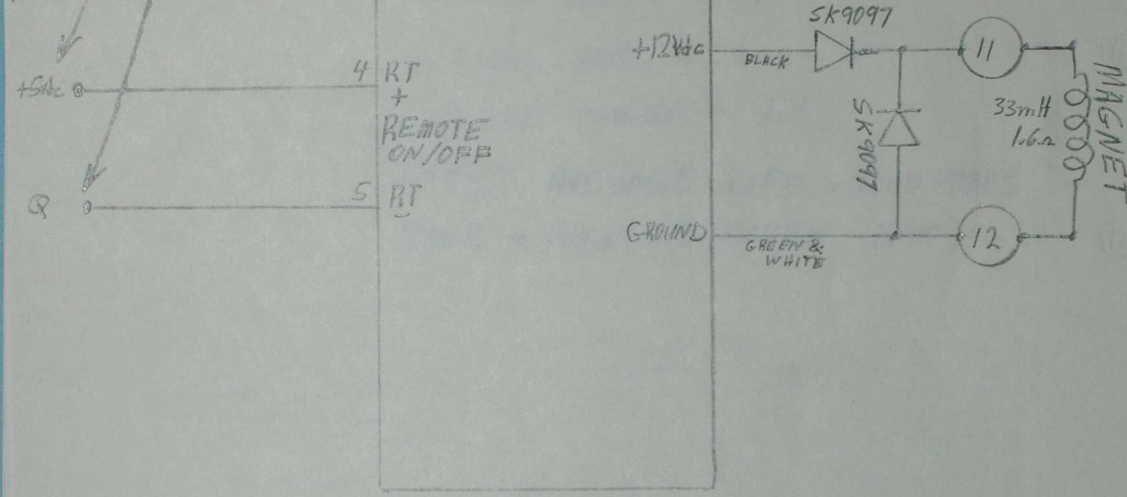

LAMP

GENERAL ELECTRIC #1487

RADIO SHACK CATALOG #272-1134

DESIGN VOLTS \rightarrow 14V

DESIGN AMPS \rightarrow .20A

CANDLE POWER \rightarrow 1.4

RATED AVERAGE LIFE \rightarrow 3000 HOURS

BASE \rightarrow MINIATURE SCREW (E-10)

OWNER'S MANUAL

Cat. No. 22-120

REGULATED DC POWER SUPPLY

13.5 VDC at 2.5 Amps

PLEASE READ BEFORE USING THIS EQUIPMENT



MICRONTA®

SPECIFICATIONS AND FEATURES

DC OUTPUT — Voltage regulated for line and load. See table I for voltage and current ratings.

TABLE I
VOLTAGE AND CURRENT RANGES

MODELS	VOLTAGE RANGE	MAXIMUM CURRENT (AMPS) AT AMBIENT TEMPERATURE				INPUT POWER*
		40°C	50°C	60°C	71°C	
LRS-52-2	2 ± 5%	15	13.7	11.1	5.9	65W.
LRS-52-5	5 ± 5%	15	13.7	11.1	5.9	118W.
LRS-52-6	6 ± 5%	13.5	12.2	9.9	5.2	127W.
LRS-52-12	12 ± 5%	7.8	6.8	4.9	2.3	131W.
LRS-52-15	15 ± 5%	6.4	5.6	4.0	1.9	135W.
LRS-52-20	20 ± 5%	4.9	4.3	3.0	1.5	137W.
LRS-52-24	24 ± 5%	4.1	3.6	2.6	1.2	132W.
LRS-52-28	28 ± 5%	3.5	3.1	2.2	1.1	132W.
LRS-52-48	48 ± 5%	2.0	1.7	1.2	0.6	130W.

*With output loaded to full current rating and input voltage at 95V AC.

Current range must be chosen to suit the appropriate maximum ambient temperature. Current ratings apply for entire voltage range.

REGULATED VOLTAGE OUTPUT

- Regulation 0.1% line or load with input variations from 95-132 or 132-95 volts AC and load variations from no load to full load.
- Ripple and Noise 10mV RMS, 35mV peak-to-peak for LRS-52-2, 5 and 6 volt models; 15mV RMS, 100mV peak-to-peak for LRS-52-12 thru LRS-52-28; 35mV RMS, 150mVpp for LRS-52-48, with either positive or negative terminal grounded.
- Temperature Coefficient Change in output voltage 0.03%/°C max.
- Remote Programming
 - External Resistor Nominal 1000 ohms/volt output.
 - Programming Voltage One-to-one voltage change.

7 Appendix: Mechanical Drawings

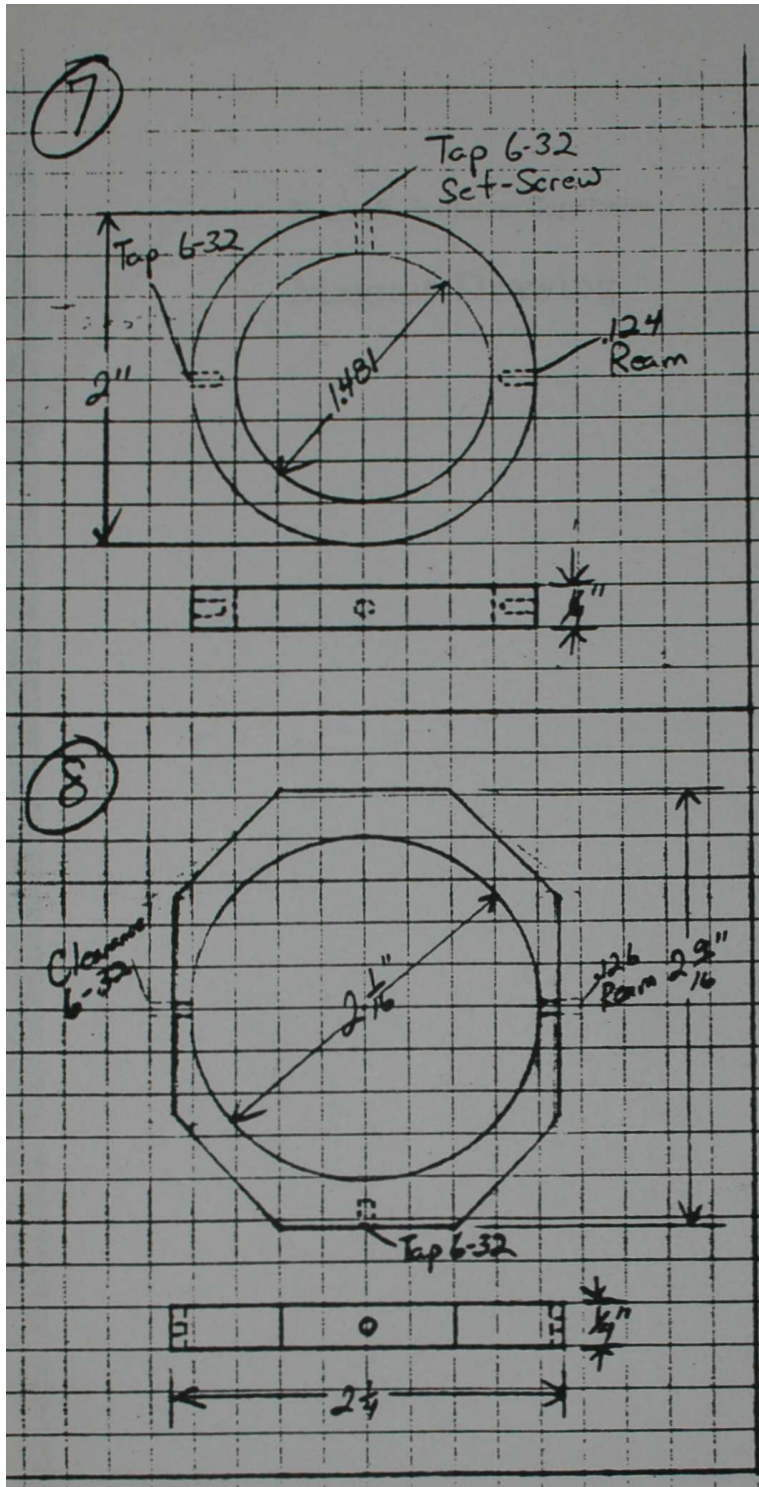

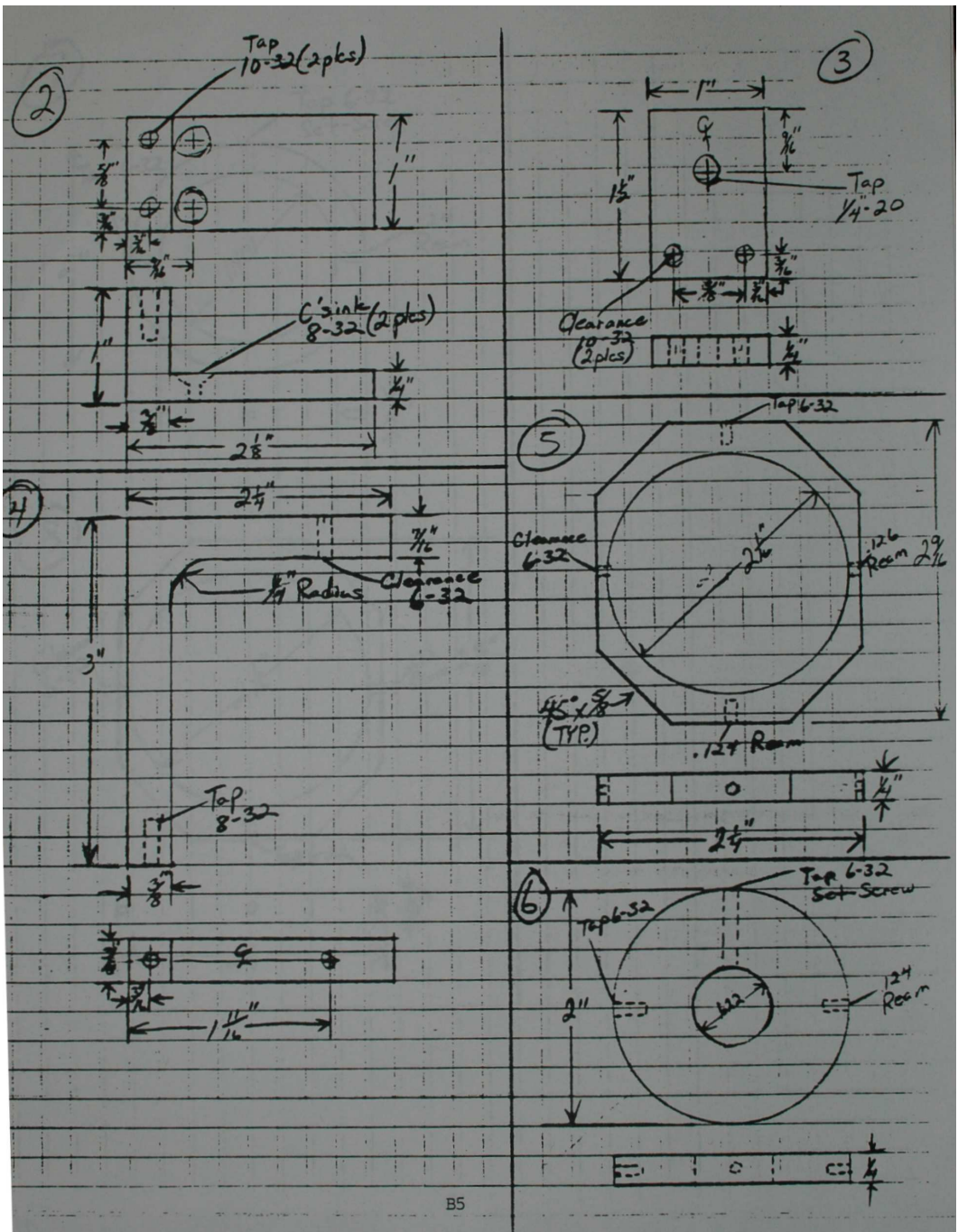

B5

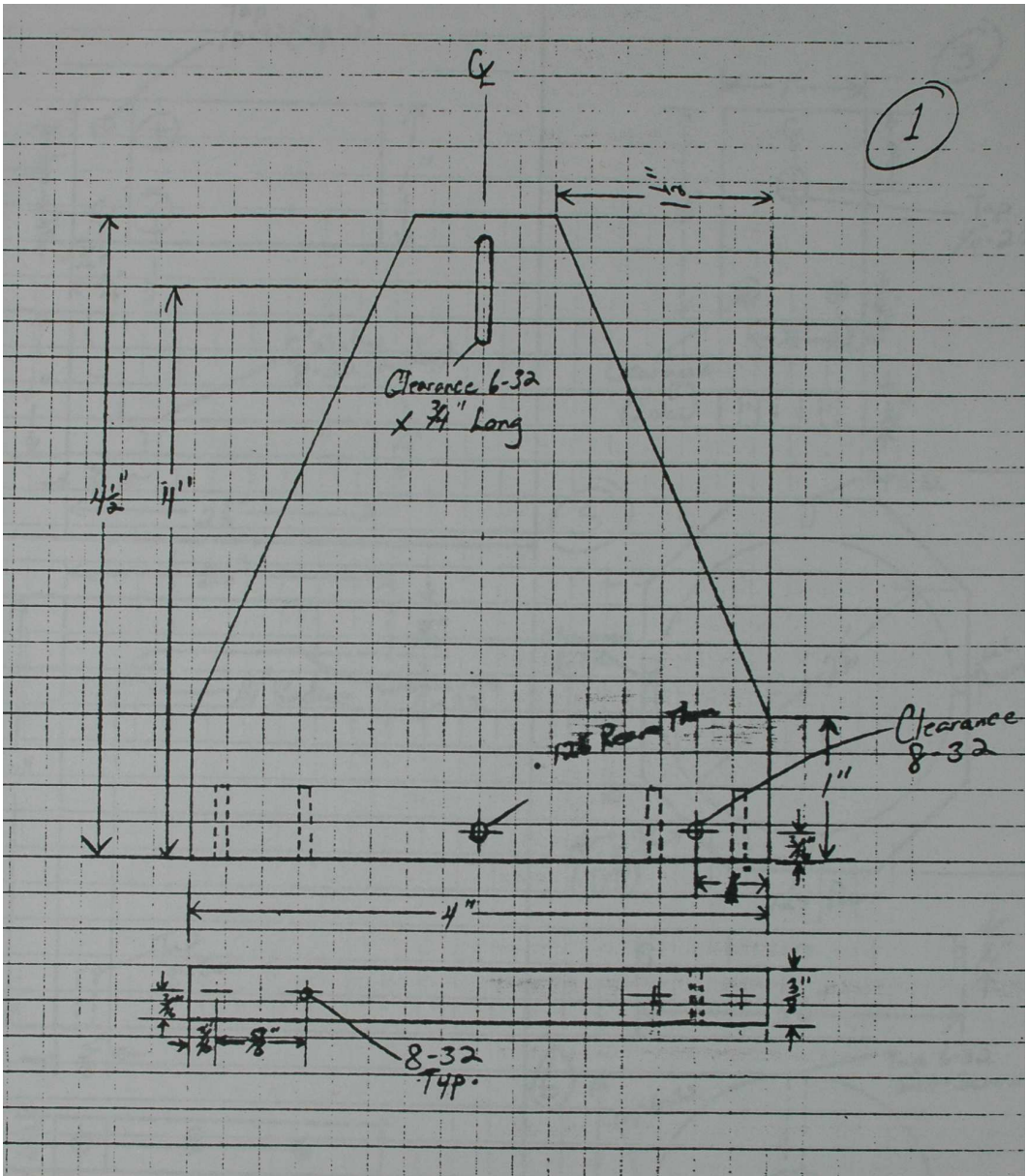

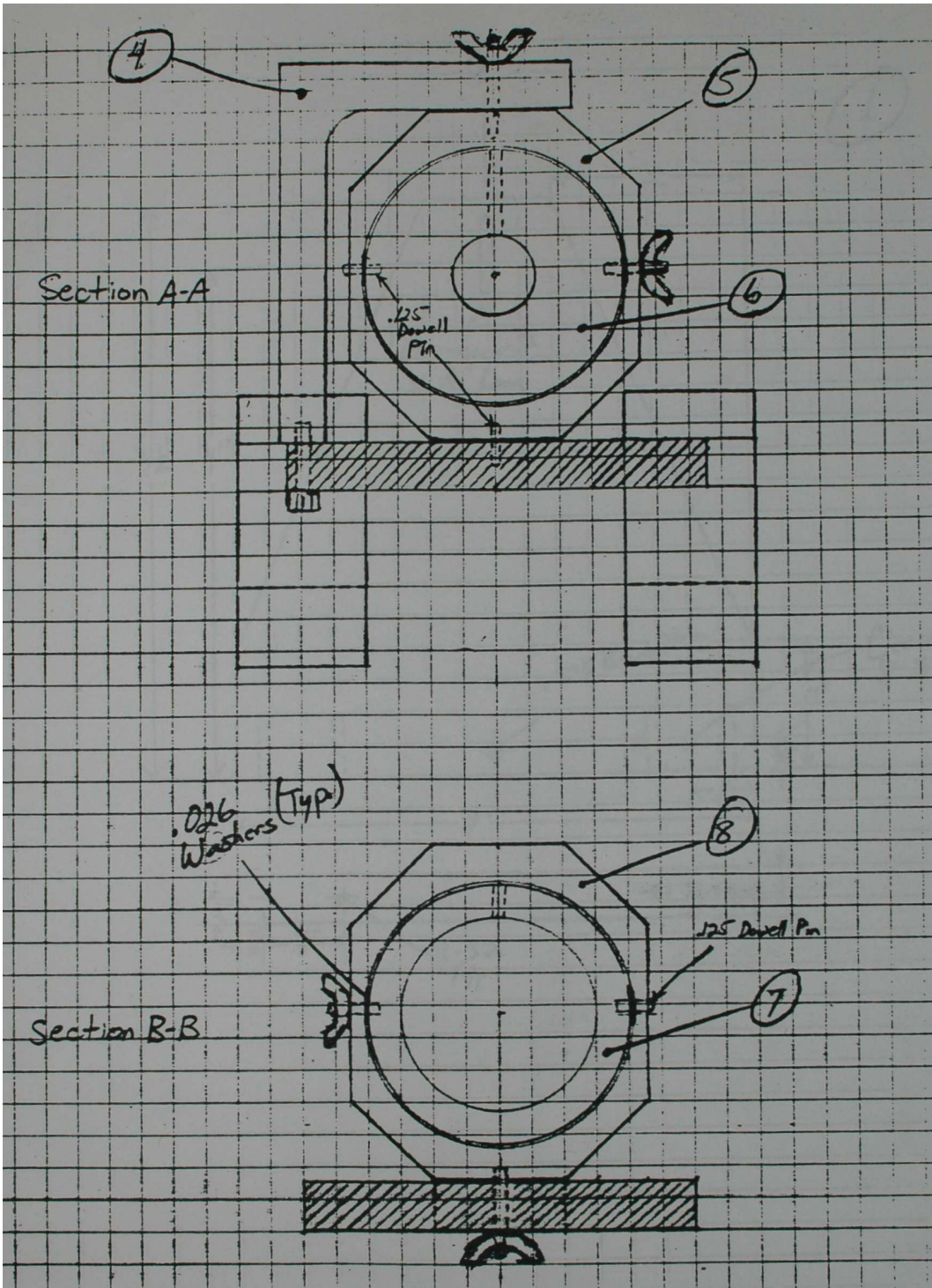

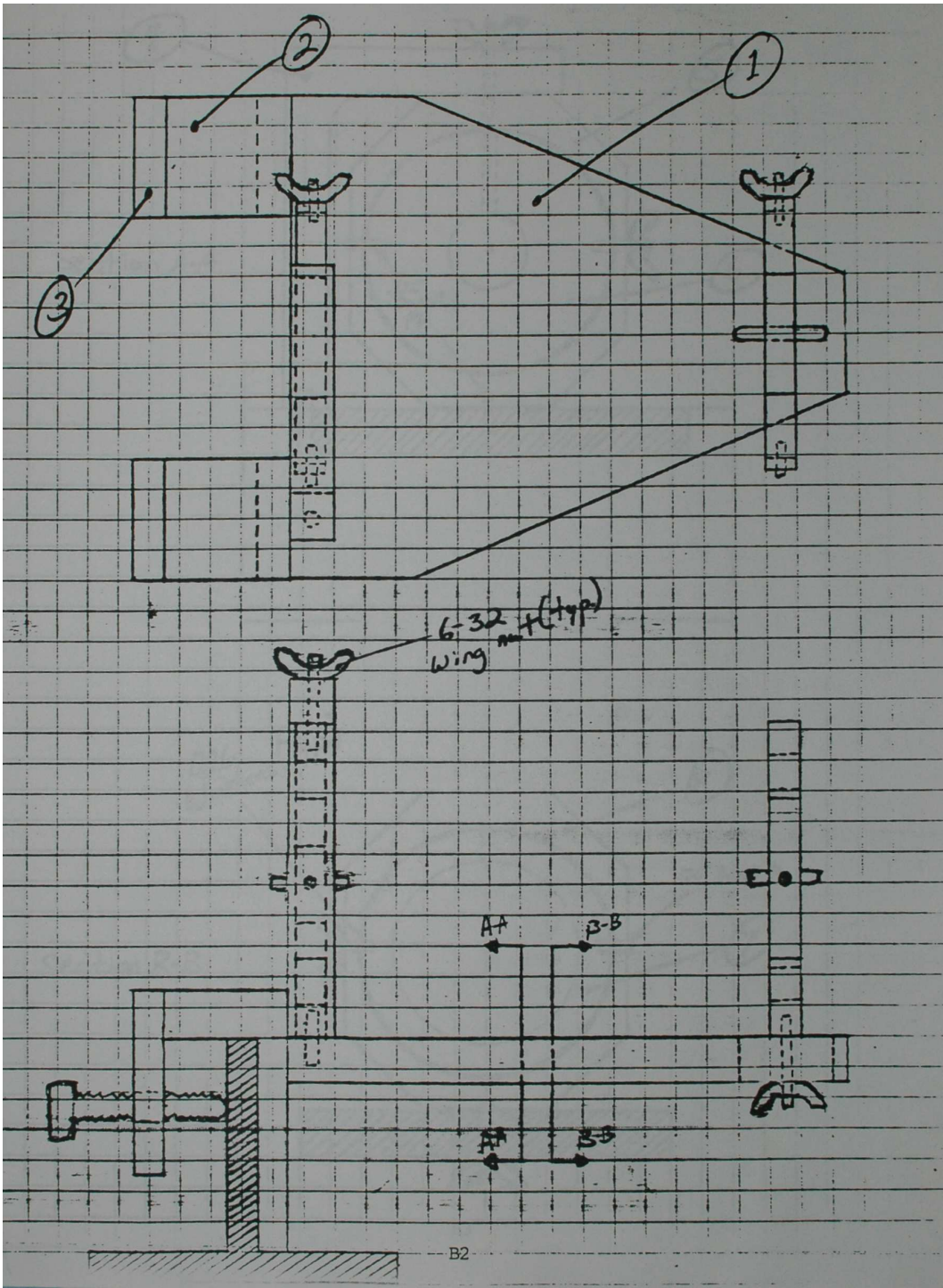

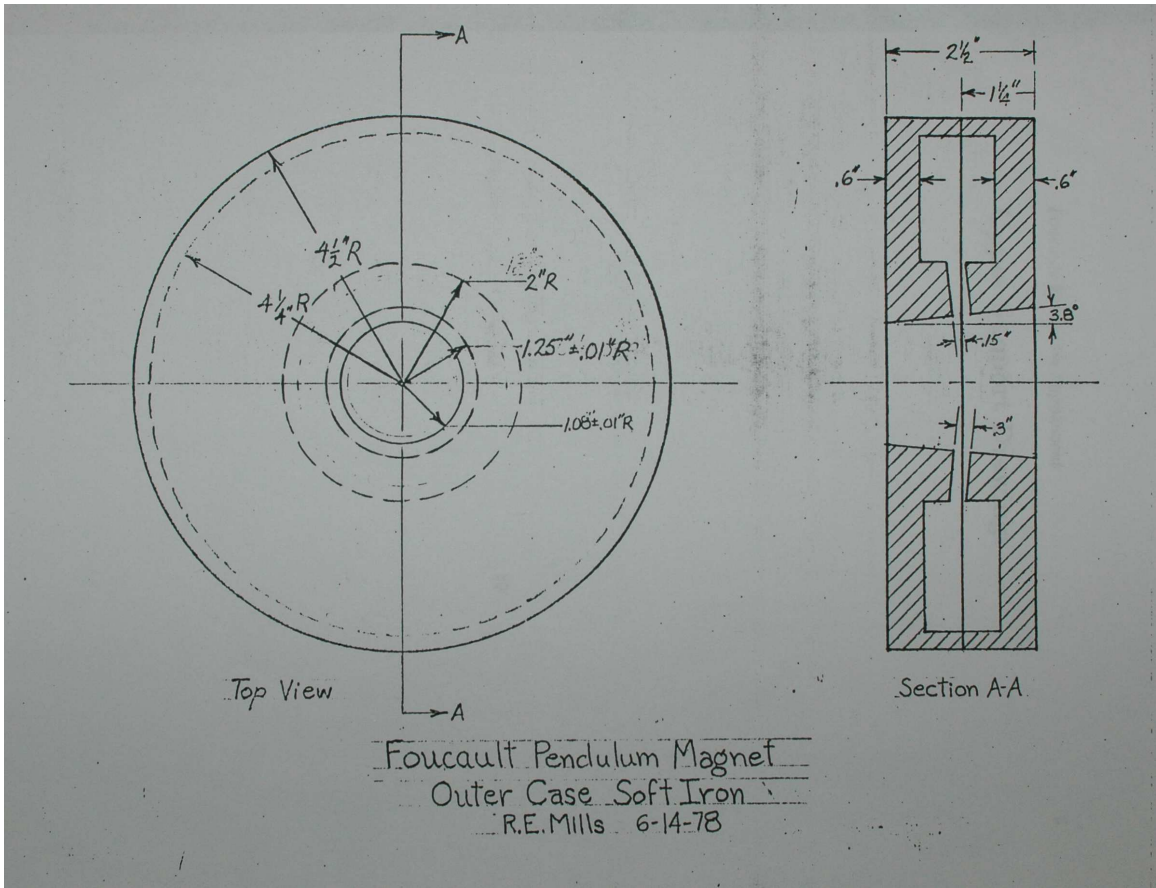

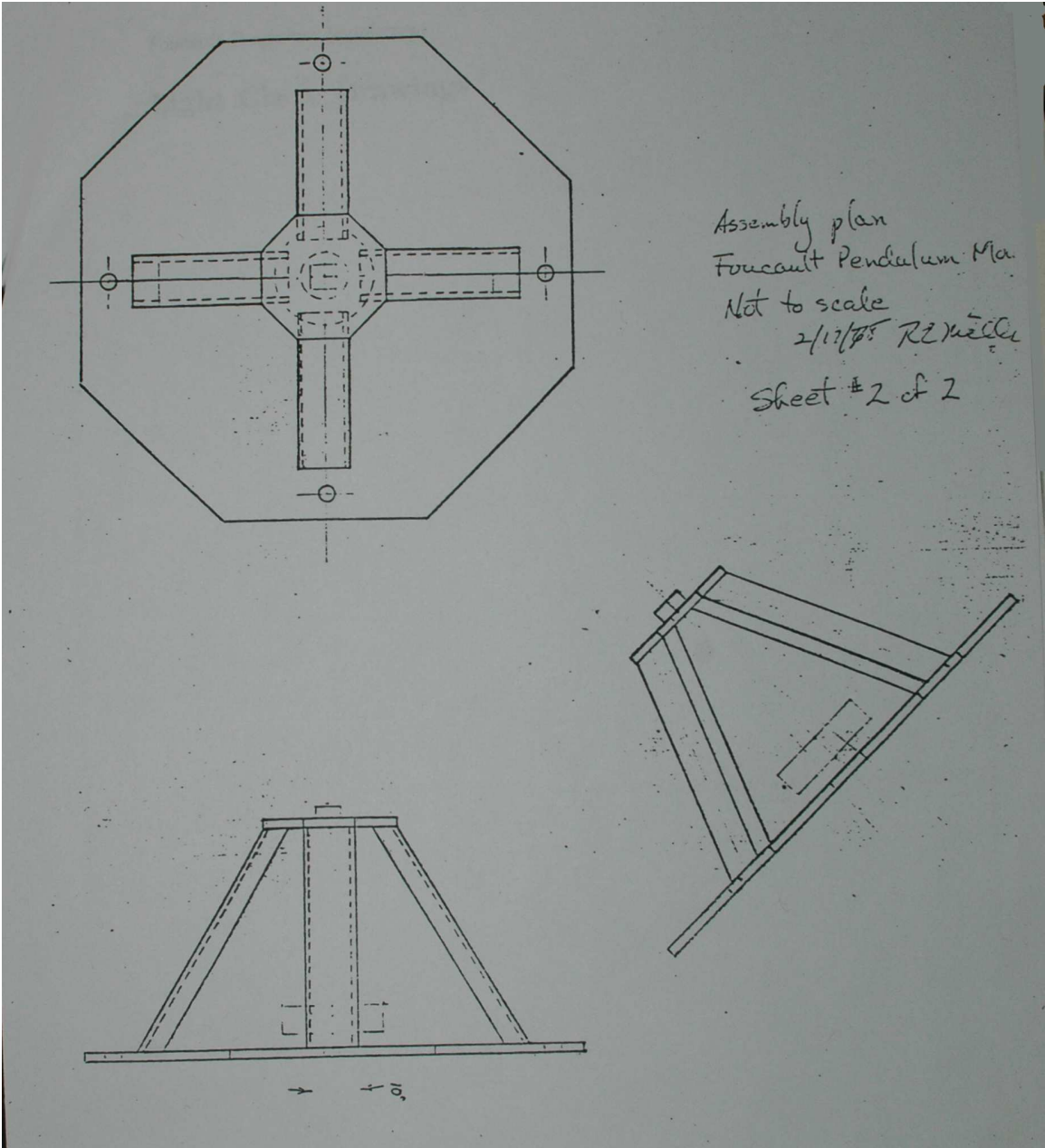

The four 2" dia holes will be made by U.C.L. machinest

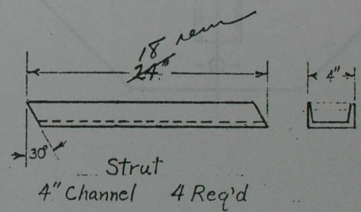
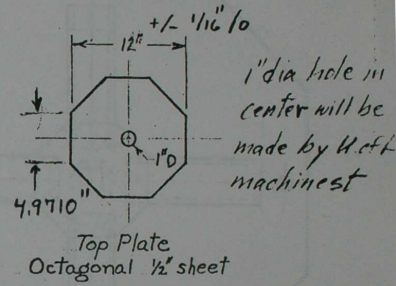
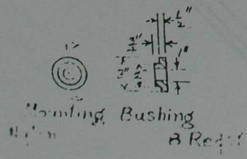
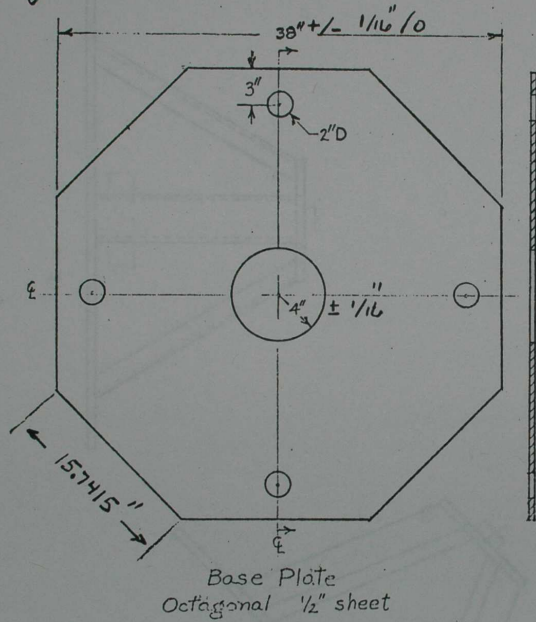

Major Components of
 Mounting Assembly
 Foucault Pendulum
 Scale 1"=10" 2/9/78 R.E.Mills
 Rev. C 2/14/78 REM

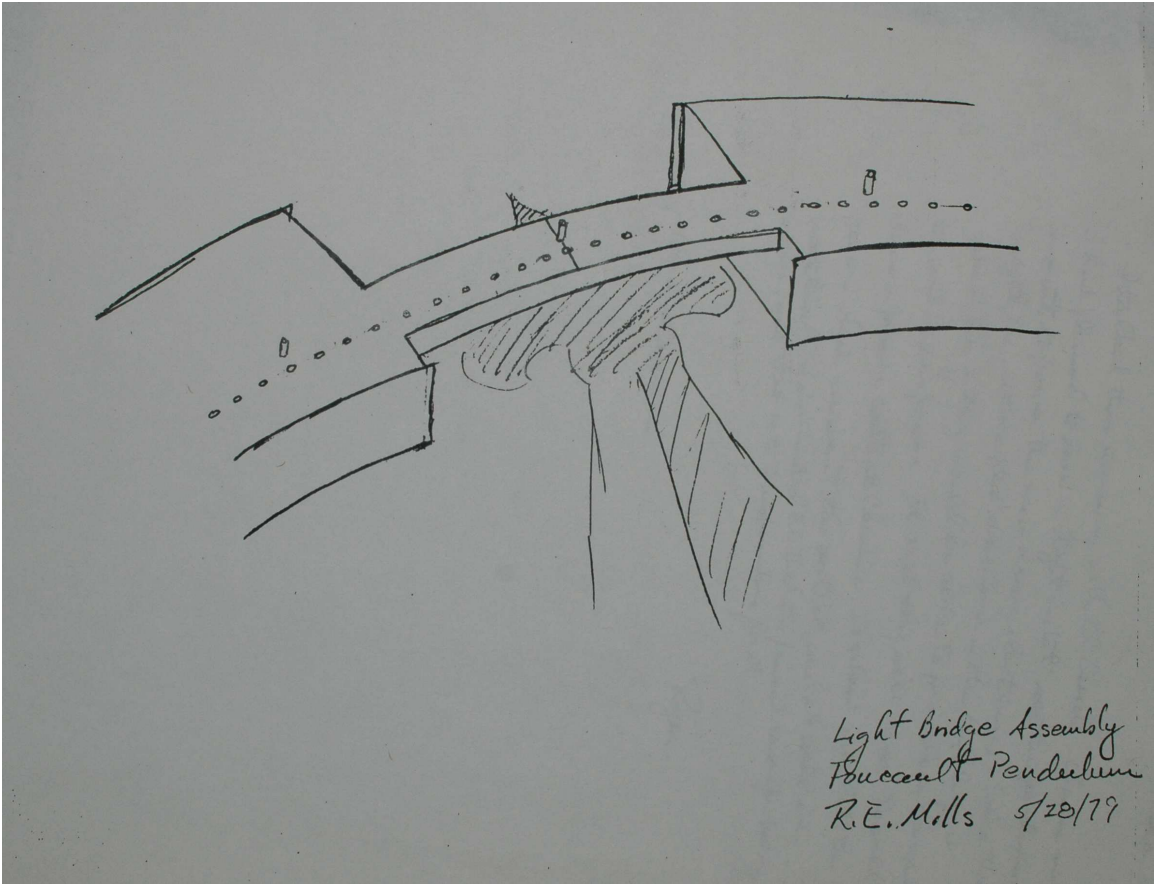

Light Bridge Assembly
Foucault Pendulum
R.E. Molls 5/20/79

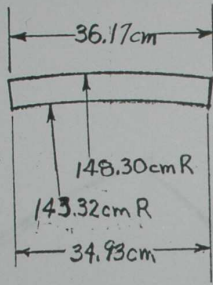

Bottom
Light Bridge

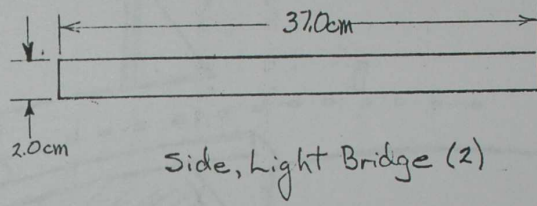

Side, Light Bridge (2)

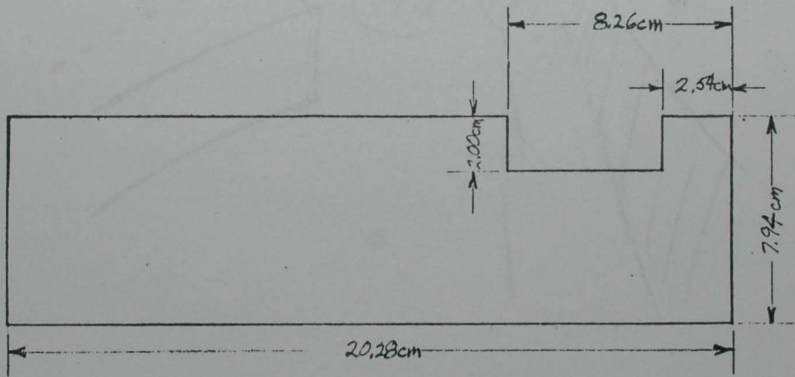

End Piece (2)
Light Display

Miscellaneous Pieces

Foucault Pendulum

R.E. Mills 5/28/79

